

# DUO CONNECTOR STOOLS

Interactive

## General Specifications





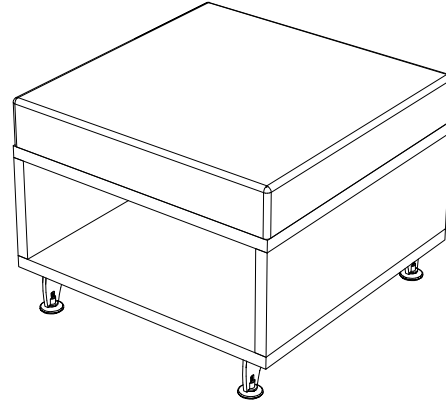

**Seat:** Fully upholstered seat cushion comprised of 4" high density foam.

**Base Assembly:** The base assembly is fabricated from 1" thick engineered wood with high-pressure laminate faces and 3mm PVC edges or premium grade oak or maple veneer faces with 3mm wood edges.

**Leg Assemblies:** Legs are fabricated from 5/16" plate steel and include a curved profile with a square mounting plate. The bottom of each leg is fitted with a threaded weld nut and 1-7/8" black leveling glide.

**Finish:** See [www.mediatechnologies.com/products/fabric/Seating](http://www.mediatechnologies.com/products/fabric/Seating) for fabric choices and **mediatechnologies®** Finish and Color Guide for additional finish choices.



Duo Connector Stool													
Model Number	Base Type	Base Enclosure	Finish	Seat	Seat Hgt.	Wgt. (lbs.)	COM Yd.	List Price					
								Grade 1 COM	Grade 2	Grade 3	Grade 4	Grade 5	Grade 6
Rectangle Stool													
 DUC-2418-USO-18	Post	Open	Veneer	Uph	18"	1		\$1,330	\$1,372	\$1,414	\$1,458	\$1,498	\$1,541
DUC-2418-USOL-18	Post	Open	HPL	Uph	18"	1		\$1,119	\$1,156	\$1,190	\$1,227	\$1,262	\$1,297
DUC-2418-USO-25	Post	Open	Veneer	Uph	25"	1		\$1,420	\$1,464	\$1,506	\$1,547	\$1,588	\$1,630
DUC-2418-USOL-25	Post	Open	HPL	Uph	25"	1		\$1,195	\$1,232	\$1,268	\$1,304	\$1,337	\$1,372
Square Stool													
 DUC-2418-USC-18	Post	Closed	Veneer	Uph	18"	1		\$1,384	\$1,425	\$1,469	\$1,512	\$1,553	\$1,595
DUC-2418-USCL-18	Post	Closed	HPL	Uph	18"	1		\$1,165	\$1,199	\$1,236	\$1,272	\$1,308	\$1,343
DUC-2418-USC-25	Post	Closed	Veneer	Uph	25"	1		\$1,476	\$1,519	\$1,561	\$1,604	\$1,645	\$1,688
DUC-2418-USCL-25	Post	Closed	HPL	Uph	25"	1		\$1,242	\$1,279	\$1,314	\$1,349	\$1,385	\$1,421
45 Degree Wedge Stool													
 DUC-2424-USO-18	Post	Open	Veneer	Uph	18"	1		\$1,466	\$1,510	\$1,550	\$1,593	\$1,637	\$1,678
DUC-2424-USOL-18	Post	Open	HPL	Uph	18"	1		\$1,234	\$1,270	\$1,306	\$1,341	\$1,377	\$1,413
DUC-2424-USO-25	Post	Open	Veneer	Uph	25"	1		\$1,561	\$1,599	\$1,642	\$1,684	\$1,729	\$1,775
DUC-2424-USOL-25	Post	Open	HPL	Uph	25"	1		\$1,314	\$1,346	\$1,383	\$1,418	\$1,457	\$1,494
 DUC-2424-USC-18	Post	Closed	Veneer	Uph	18"	1		\$1,521	\$1,564	\$1,606	\$1,648	\$1,691	\$1,733
DUC-2424-USCL-18	Post	Closed	HPL	Uph	18"	1		\$1,281	\$1,316	\$1,352	\$1,388	\$1,423	\$1,460
DUC-2424-USC-25	Post	Closed	Veneer	Uph	25"	1		\$1,613	\$1,655	\$1,698	\$1,740	\$1,785	\$1,832
DUC-2424-USCL-25	Post	Closed	HPL	Uph	25"	1		\$1,358	\$1,393	\$1,429	\$1,465	\$1,503	\$1,542
 DUC-2420-USCR45-18	Post	Closed	Veneer	Uph	18"	1		\$1,934	\$1,977	\$2,019	\$2,062	\$2,105	\$2,146
DUC-2420-USCR45L-18	Post	Closed	HPL	Uph	18"	1		\$1,628	\$1,665	\$1,699	\$1,735	\$1,772	\$1,807
DUC-2420-USCR45-25	Post	Closed	Veneer	Uph	25"	1		\$1,988	\$2,031	\$2,073	\$2,116	\$2,141	\$2,226
DUC-2420-USCR45L-25	Post	Closed	HPL	Uph	25"	1		\$1,674	\$1,710	\$1,745	\$1,781	\$1,827	\$1,874
 DUC-2420-USCFR45-18	Post	Closed	Veneer	Uph	18"	1		\$1,934	\$1,977	\$2,019	\$2,062	\$2,105	\$2,146
DUC-2420-USCFR45L-18	Post	Closed	HPL	Uph	18"	1		\$1,628	\$1,665	\$1,699	\$1,735	\$1,772	\$1,807
DUC-2420-USCFR45-25	Post	Closed	Veneer	Uph	25"	1		\$1,988	\$2,031	\$2,073	\$2,116	\$2,141	\$2,226
DUC-2420-USCFR45L-25	Post	Closed	HPL	Uph	25"	1		\$1,674	\$1,710	\$1,745	\$1,781	\$1,827	\$1,874

**Required to order:**

Model # including:

- wood selection and wood finish (if applicable)
- HPL selection and PVC selection (if applicable)
- fabric selection
- powder coat selection

**Note:**

Veneer prices listed above are for an oak construction. Seats constructed of maple or other materials may incur an upcharge

# DUO CONNECTOR STOOLS

Interactive

## Duo Connector Stool

Model Number	Base Type	Base Enclosure	Finish	Seat	Seat Hgt.	Wgt. (lbs.)	COM Yd.	List Price					
								Grade 1 COM	Grade 2	Grade 3	Grade 4	Grade 5	Grade 6
	DUC-2436-USOR45-18	Post	Open	Veneer	Uph	18"	1	\$1,788	\$1,830	\$1,873	\$1,916	\$1,958	\$2,002
	DUC-2436-USOR4L5-18	Post	Open	HPL	Uph	18"	1	\$1,505	\$1,541	\$1,576	\$1,613	\$1,648	\$1,684
	DUC-2436-USOR45-25	Post	Open	Veneer	Uph	25"	1	\$1,841	\$1,882	\$1,925	\$1,969	\$2,019	\$2,062
	DUC-2436-USOR45L-25	Post	Open	HPL	Uph	25"	1	\$1,549	\$1,585	\$1,621	\$1,657	\$1,699	\$1,744
<b>90 Degree Wedge</b>													
	DUC-2435-USCR90-18	Post	Closed	Veneer	Uph	18"	1	\$1,945	\$1,988	\$2,031	\$2,073	\$2,116	\$2,159
	DUC-2435-USCR90L-18	Post	Closed	HPL	Uph	18"	1	\$1,638	\$1,674	\$1,710	\$1,745	\$1,781	\$1,818
	DUC-2435-USCR90-25	Post	Closed	Veneer	Uph	25"	1	\$2,026	\$2,069	\$2,111	\$2,154	\$2,210	\$2,266
	DUC-2435-USCR90L-25	Post	Closed	HPL	Uph	25"	1	\$1,706	\$1,741	\$1,777	\$1,814	\$1,860	\$1,908
	DUC-2452-USOR90-18	Post	Open	Veneer	Uph	18"	1.5	\$2,596	\$2,659	\$2,720	\$2,783	\$2,844	\$3,038
	DUC-2452-USOR90L-18	Post	Open	HPL	Uph	18"	1.5	\$2,186	\$2,238	\$2,289	\$2,342	\$2,394	\$2,558
	DUC-2452-USOR90-25	Post	Open	Veneer	Uph	25"	1.5	\$2,729	\$2,791	\$2,852	\$2,916	\$2,991	\$3,067
	DUC-2452-USOR90L-25	Post	Open	HPL	Uph	25"	1.5	\$2,298	\$2,350	\$2,402	\$2,455	\$2,518	\$2,582

**Required to order:**

Model # including:

- wood selection and wood finish (if applicable)
- HPL selection and PVC selection (if applicable)
- fabric selection
- powder coat selection

**Note:**

Veneer prices listed above are for an oak construction. Seats constructed of maple or other materials may incur an upcharge